

ADVANCED PROCESSOR
ARCHITECTURES AND MEMORY
ORGANISATION –
Lesson-6: Memory Addresses
Allocation and Memory Map

1. Memory Allocation To Program Segments and Blocks

Functions, Processes, Data and Stacks at the Various Segments of Memory

Segment wise memory allocation in four segments; Code, Data, Stack and Extra (for examples, image, String)

Segments and Paging at the Memory

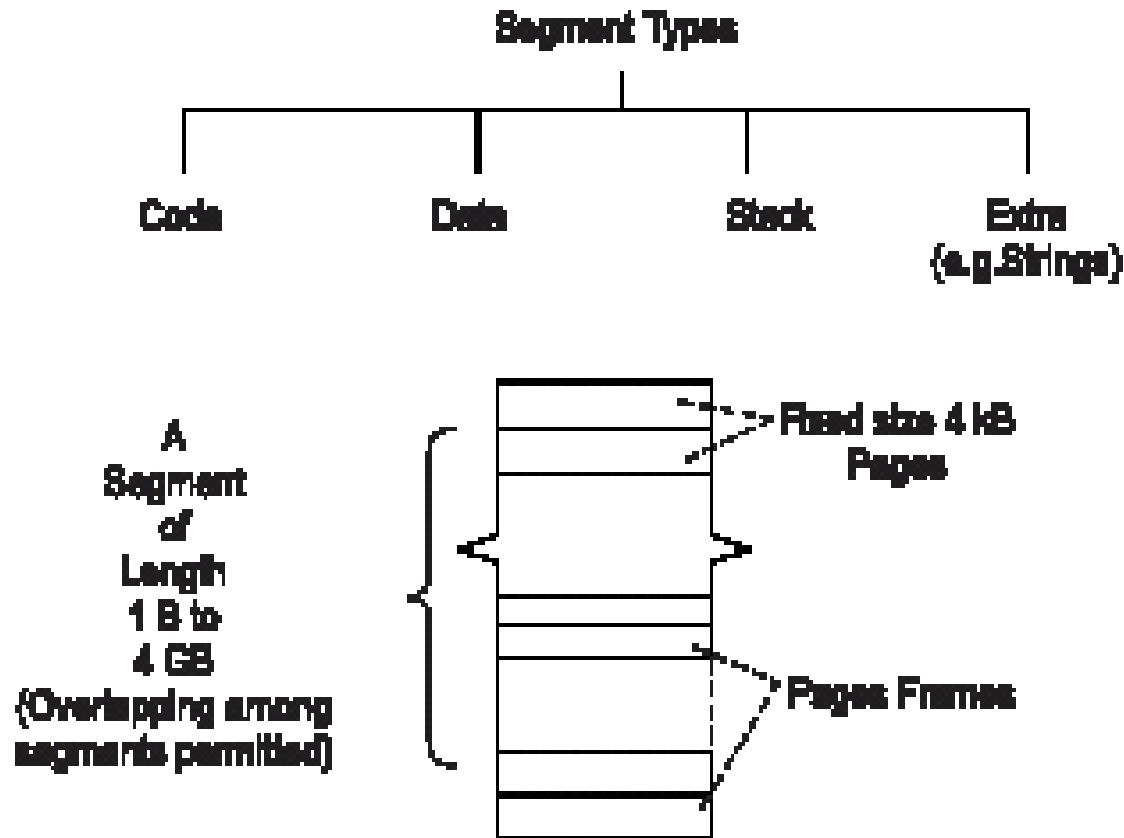

Different Data Structures at the Various Memory Blocks

- 1) Stacks – Return addresses on the nested calls, Sets of LIFO (Last In First Out) retrievable data, Saved Contexts of the tasks as the stacks

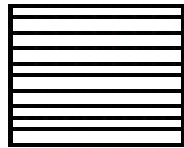

Block
 Floating Point
 Addressable in
 Memory cache

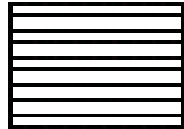

Block
 Floating Point
 Addressable in
 L1 Cache

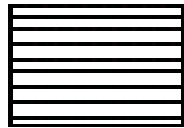

Block
 Floating Point
 Addressable - Not in
 Cache



Block
 Floating Point
 Addressable - Not in
 Cache

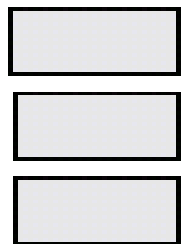

Block
 Floating Point
 Addressable
 Not in
 Cache

- 2) Arrays – One dimensional or multidimensional
- 3) Queues – Sets of FIFO (First In First Out) retrievable data; Circular Queue (Example- a Printer Buffer); Block Queue (Example- a network stack)

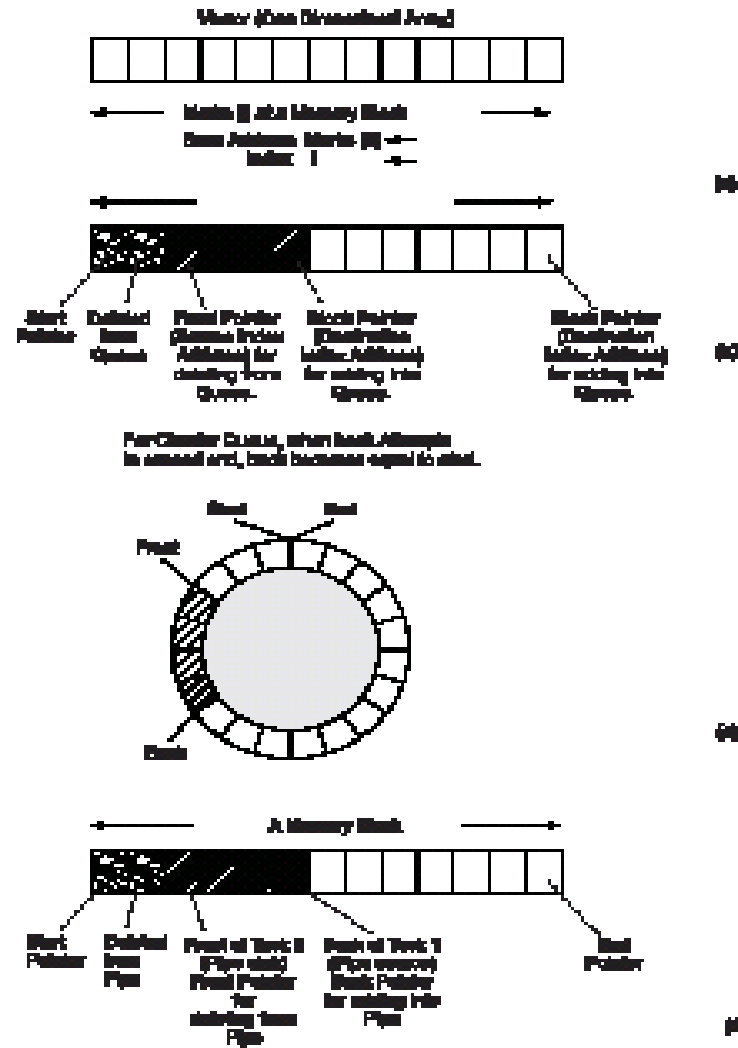

- 4) Table
- 5) Look up Table – Look-up-table row first column points to another memory block of a data structure data
- 6) List: In a list element, a data structure of an item also points to the next item
- 7) Process Control Block [Refer Chapter 7 Lesson –1]

2. Memory Map

Memory Map

Map to show the program and data allocation of the addresses to ROM, RAM, EEPROM or Flash in the system

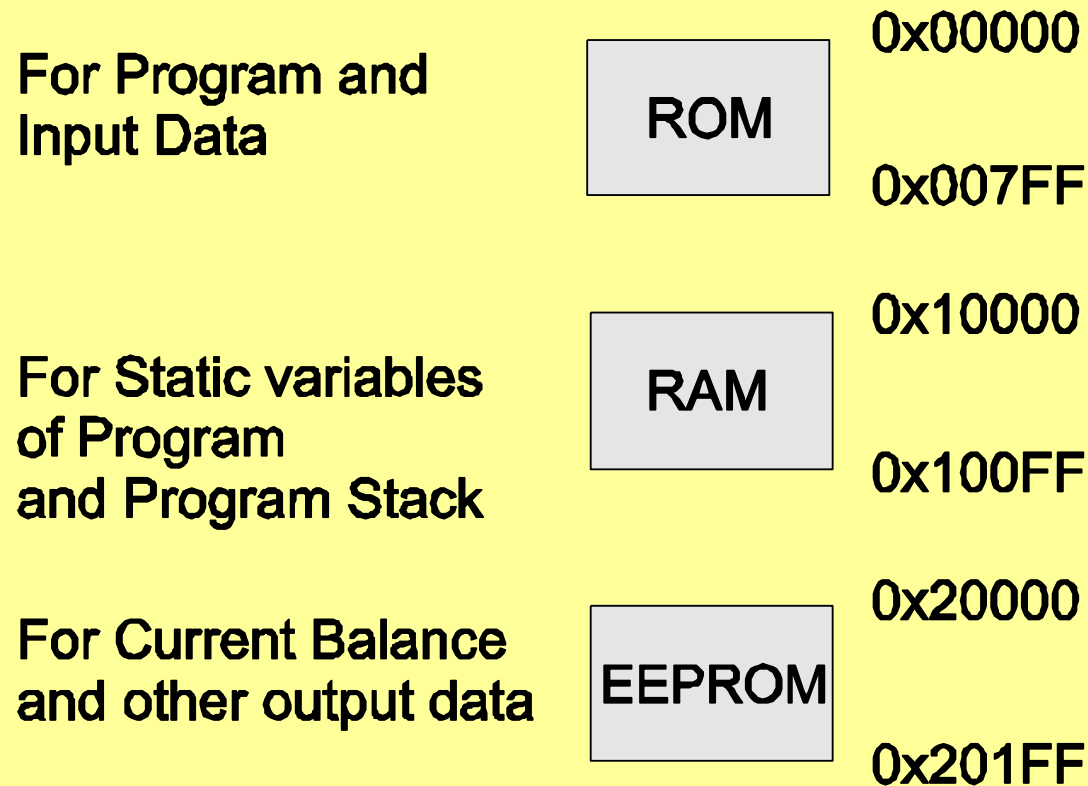

**Memory map for an exemplary embedded system,
smart card needing 2 kB memory**

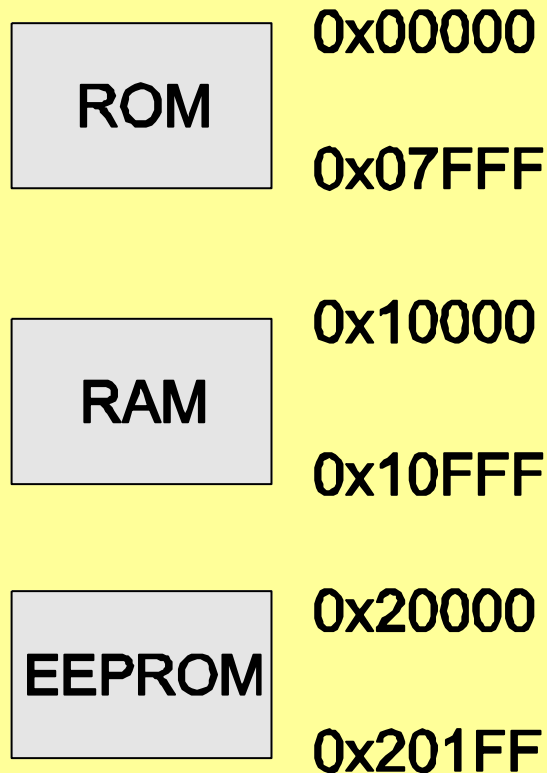

Memory map for an exemplary Java embedded card with software for encrypting and deciphering the transactions

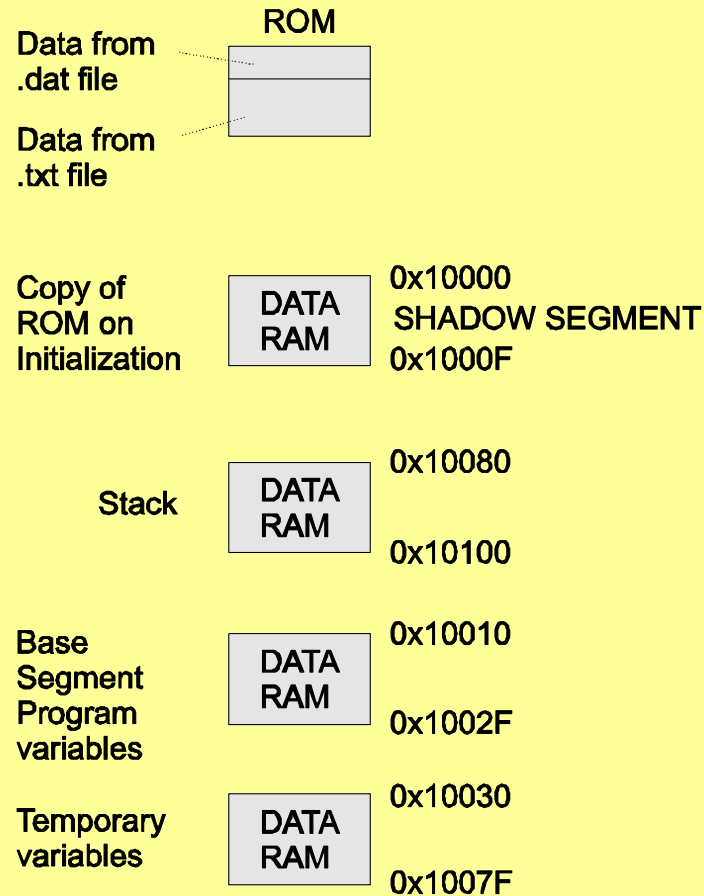

Memory map sections in a smart card

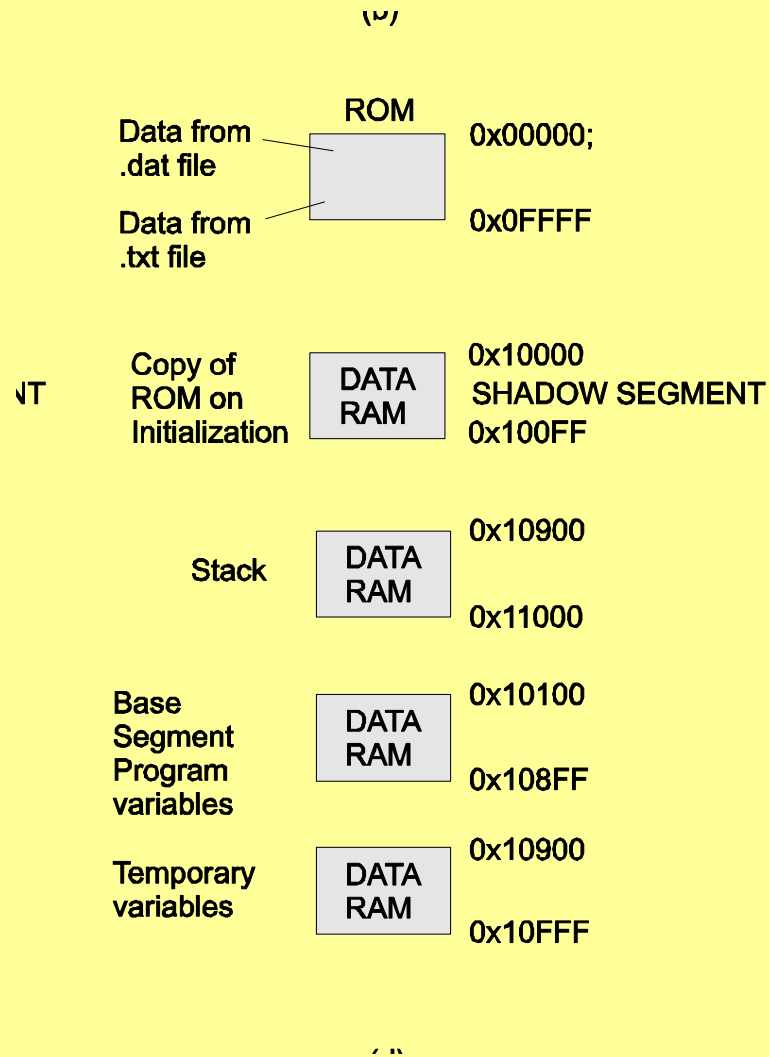

Memory map sections in another smart card

Summary

We learnt

- Allocations to various Segments and data structures
- Memory map of Exemplary cases

End of Lesson 6 of Chapter 4
on
Memory Addresses Allocation and
Memory Map